

M.K. plastics

CORPORATION

SERVING THE NEEDS OF MODERN INDUSTRY

AXIJET[®] LEADLAG[™]

EXHAUST FAN CONTROL SYSTEM
(Patent Pending)



INTRODUCTION AND FEATURES



AXIJET® LEADLAG™ EXHAUST FAN CONTROL SYSTEM

INTRODUCTION

Laboratory Exhaust Systems that utilize multiple fans in a N + 1 design must sequence the standby fan in order to prevent bearing and drive damage due to stagnancy. Since laboratory systems typically operate 24 hours per day it is impractical and unsafe to simply turn fans on and off, since this would disrupt the system static pressure of the manifold exhaust system and would jeopardize the safe exhaust of the laboratory exhaust system.

The Leadlag™ controller has an additional feature that will shut down a fan when the total system airflow has been decreased by that fan exhaust volume. This feature would be applicable during off hours such as night mode, vacation periods or a change in system requirements.

The LEADLAG™ Exhaust Fan Control System does the following...

1. Reads and maintains the set static pressure in the exhaust system.
2. Automatically activates the standby fan while simultaneously deactivating one of the lead running fans; preserving a constant pressure in the bypass air plenum.
3. The design static pressure will be maintained within +/- 10% during any Leadlag™ sequence. Additionally, the static pressure variation will last no longer than 30 seconds.
4. Maintains the necessary exhaust from the facility by modulating of the bypass damper which will maintain full exhaust fan design CFM. This feature ensures the design stack height. Alternatively, fans can be sequenced off in lieu of bypass air for energy saving.
5. Field Modifiable Programming.

How it works...

1. The Axijet Leadlag™ controller operations are controlled by a main panel inside the building called the PLC Control Panel Unit (within a NEMA 1 enclosure). The Leadlag™ controller monitors the activated fans for hours of operation.
2. One lead fan will be deactivated after a predetermined number of operating hours and a standby fan will be activated. During this process, the Leadlag™ controller monitors the plenum pressure and adjusts the bypass damper.
3. The Leadlag™ controller also adjusts the rate at which the isolation damper opens for the activated standby fan and the deactivated lead running fan. The static pressure variation that this Leadlag™ sequence will be less than +/- 10% of the design static pressure and will last no longer than 30 seconds.
4. The Leadlag™ controller, furthermore, monitors the activated lead running fans for possible failures. If a fan does fail, an alarm light will illuminate and denote which fan experienced a failure. The power is cut to the failed fan and the next available standby fan becomes activated (as described in the steps 1. to 3. above).
5. The secondary panel is the Auxiliary Actuator Pressure Control Unit, (within a NEMA 3R enclosure) is normally mounted on the exhaust intake plenum. The AAPCU contains the static pressure sensors and the terminal wiring connections. It is linked to the microprocessor in the main Leadlag™ Control Panel Unit and receives input signals for static pressure control, damper operation, and optional features such as temperature, bearing/vibration failure, fan inlet pressure & flow, damper position and fan speed. Then, output signals are sent to the damper actuators and the fan motor starter.
6. Energy savings are achieved through monitoring the static pressure and design flow. The Leadlag™ PLC Control Panel unit may be used in conjunction with the bypass damper, and it may additionally deactivate a fan when too much air is being bypassed.

COST SAVING EXAMPLE



AXIJET® LEADLAG™ EXHAUST FAN CONTROL SYSTEM

COST SAVING EXAMPLES

Example 1

A system designed for 90,000 CFM @ 5" SP. 5 fans in operation with 22,500 CFM of bypass air. The fan selected is an AXIJET F-4025 for 22,500 CFM, 31.61 BHP each (158.05 total system BHP). For the total system in operation as designed the annual cost of operation is approximately \$115,000.00 (based on total BHP of 158.05 operating 24/7/365 i.e. 8,760 hours per year @ \$0.10 /kwh). The Axijet Leadlag™ controller is designed to operate in a N + 1 scenario, which would reflect 4 fans in operation with no bypass air and a fifth fan to be sequenced and cycle off. In the example given that would reflect annual savings of approximately \$23,000.00, or an annual cost of approximately \$92,000.00

Example 2

The same design as above with an addition of night mode.

During the normal operation of the exhaust system 90,000 CFM is exhausted. The night mode has been determined that between the hours of 10:00 pm and 6:00 am the exhaust requirement is reduced to 60,000 CFM. In this scenario the system would use 3 fans each at 22,500 CFM, (94.83 total system BHP) for a total of 67,500 cfm with 7,500 CFM bypass air. In this scenario 1 fan can be cycled off for 8 hours a day. The revised cost of operation based on 16 hours at 158.05 BHP and 8 hours at 94.83 BHP is approximately \$84,000.00 providing additional savings of approximately \$8,000.00 per year. The night mode hours and CFM requirements are field programmable.

Example 3

The same design as above with an addition of night mode and a VFD.

During the normal operation of the exhaust system 90,000 CFM is exhausted. The night mode has been determined that between the hours of 10:00 pm and 6:00 am the exhaust requirement is reduced to 60,000 CFM. In this scenario the VFD will slow the 4 AXIJET F-4025 fans to 895 rpm each at 15,000 CFM (60,000 total CFM) and the BHP for each fan is 17.80 (71.20 total system BHP) no bypass air is required. The revised cost of operation based on 16 hours at 158.05 BHP and 8 hours at 71.20 BHP is approximately \$78,500.00 providing additional savings of approximately \$5,500.00 per year. The night mode hours and CFM requirements are field programmable.

The table below shows daily cost per motor and potential savings. Divide the daily rate by the hours of standby and multiply by 365 to calculate annual motor cost and potential saving.

FAN POWER		ENERGY COST PER FAN					
HP	KW	PER DAY			PER YEAR		
		\$0.050	\$0.075	\$0.100	\$0.050	\$0.075	\$0.100
5	3.7	\$4.97	\$7.45	\$9.93	\$1,813	\$2,719	\$3,626
7.5	5.6	\$7.45	\$11.18	\$14.90	\$2,719	\$4,079	\$5,439
10	7.5	\$9.93	\$14.90	\$19.87	\$3,626	\$5,439	\$7,251
15	11.2	\$14.90	\$22.35	\$29.80	\$5,439	\$8,158	\$10,877
20	14.9	\$19.87	\$29.80	\$39.73	\$7,251	\$10,877	\$14,503
30	22.4	\$29.80	\$44.70	\$59.60	\$10,877	\$16,316	\$21,754
40	29.8	\$39.73	\$59.60	\$79.47	\$14,503	\$21,754	\$29,005
50	37.3	\$49.67	\$74.50	\$99.33	\$18,128	\$27,193	\$36,257
75	55.9	\$74.50	\$111.75	\$149.00	\$27,193	\$40,789	\$54,385
100	74.5	\$99.33	\$149.00	\$198.67	\$36,257	\$54,385	\$72,513

Cost of operations are based on motors with minimum efficiency factor of 90%

AXIJET® LEADLAG™ THREE FAN SYSTEM (ONE FAN ON STANDBY)

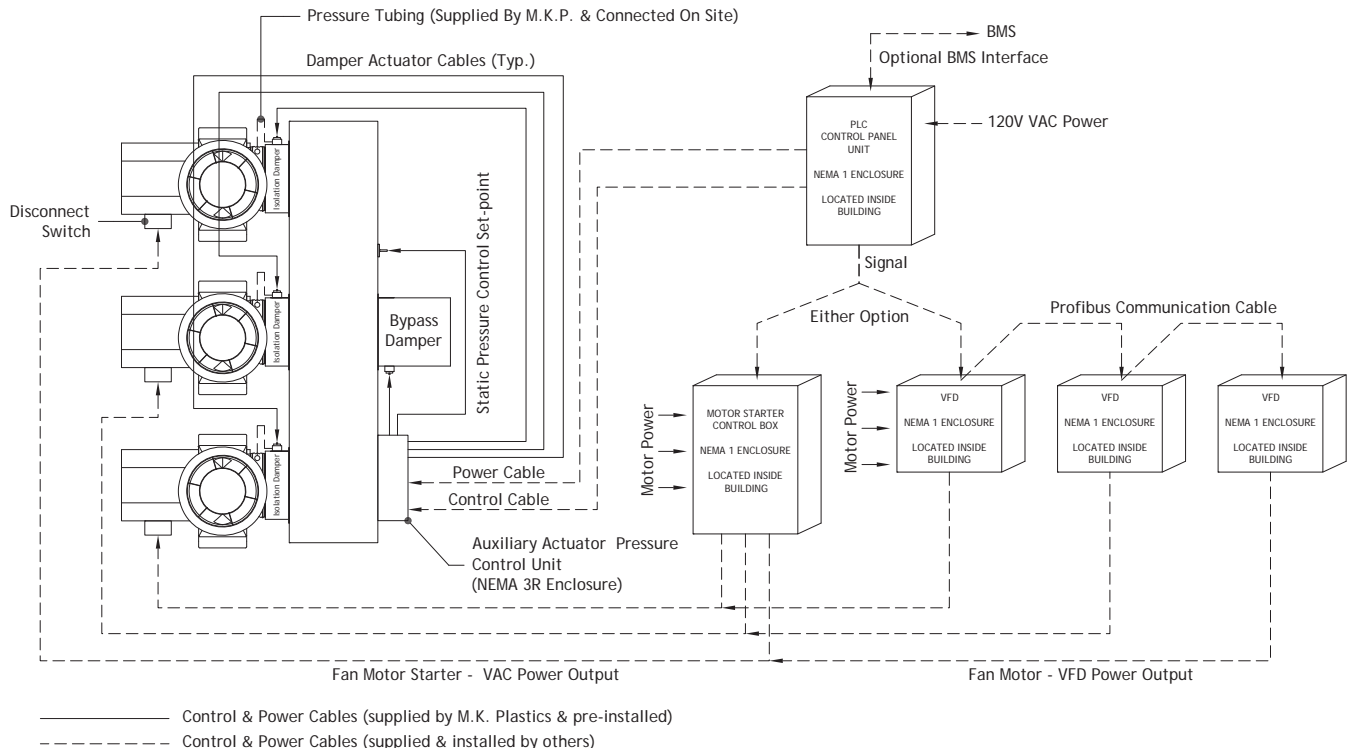

NOTE: Leadlag™ can control any number of fans, the above schematic is a 'typical' layout.

AUXILIARY ACTUATOR PRESSURE CONTROL UNIT

NEMA 3R enclosure, mounted outside, is linked to the PLC Control Panel Unit. The unit receives and sends signals for pressure control, damper actuator operation, fan motor starters and optional devices such as vibration failure.

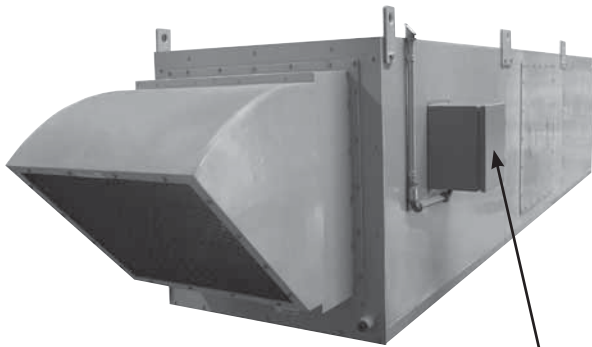

Auxiliary Actuator Pressure Control Unit
(Attached to Bypass Plenum)



PLC CONTROL PANEL UNIT

NEMA 1 enclosure, located inside the building, that controls the functioning of the Leadlag™ operation through a microprocessor.

AVAILABLE OPTIONS...

- Standard Leadlag™ operation - cycling between Lead & Lag fans, no pressure control.
- Leadlag control system with static pressure control - static pressure set point is field programmable on the PLC. Available static pressure sensor locations -
 - ◇ Static pressure sensor in the plenum
 - ◇ Remote static pressure location
 - ◇ Remote static pressure location with multiple inputs (lowest point or average reading)
 - ◇ Static pressure in plenum + ductwork location + remote location (static pressure reading will be combined total)
- Integrated or Remote Leadlag™ Start/Stop mode.
 - ◇ The Leadlag™ can be initiated or stopped at the PLC Control Panel
 - ◇ The Leadlag™ can be initiated or stopped at a remote location according to the customer's needs
- Fan failure indicator (alarm), enabling to switch from Lead Fan to Lag Fan.
 - ◇ Motor overload
 - ◇ Temperature limit
 - ◇ Vibration limit
 - ◇ Belt failure
- Automatic system restart after power recovery in the event of power failure.
- Bypass Energy Saving Mode - With Energy Saving Mode enabled, the PLC will monitor the bypass damper(s) position and if it is determined that the system is receiving too much bypass air, the PLC will shut down a fan. System static pressure will then be maintained by reducing and modulating the bypass air. When the system static pressure is reduced or flow demand rises, the PLC will engage one of the Lag fans.
- BACnet or LonWorks communication Protocol compatible for Building Automation Control Networks.
- Network IP for internet connection to facilitate M.K. Plastics in monitoring the functioning of the system remotely - two IP Addresses are required.
- Fire/smoke mode.
 - ◇ Fan on or off (depending on State or Local Authority Codes)
- Compatibility with fans controlled by Variable Frequency Drives (VFD), via. Profibus. (NOTE: When using VFD's, care should be taken when programming the drives to allow for minimum desired fan flow, outlet velocity and plume height of the fans).

The Leadlag Control System not only manages operation, but also informs the end user of what is going on - Lead/Lag cycle, date & time, default energy mode, fan run time, static pressure set point, actual static pressure, fan status (on/off), VFD/fan speed, bypass damper position, fan flow alarm, fan isolation damper alarm.

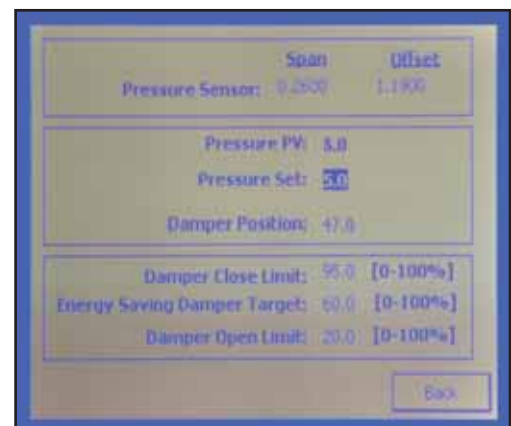

PLC Touch Pad Screen Display

CYCLE FAN ON/OFF - Constant Speed Fans, no VFD & no Bypass Dampers - (N+1)

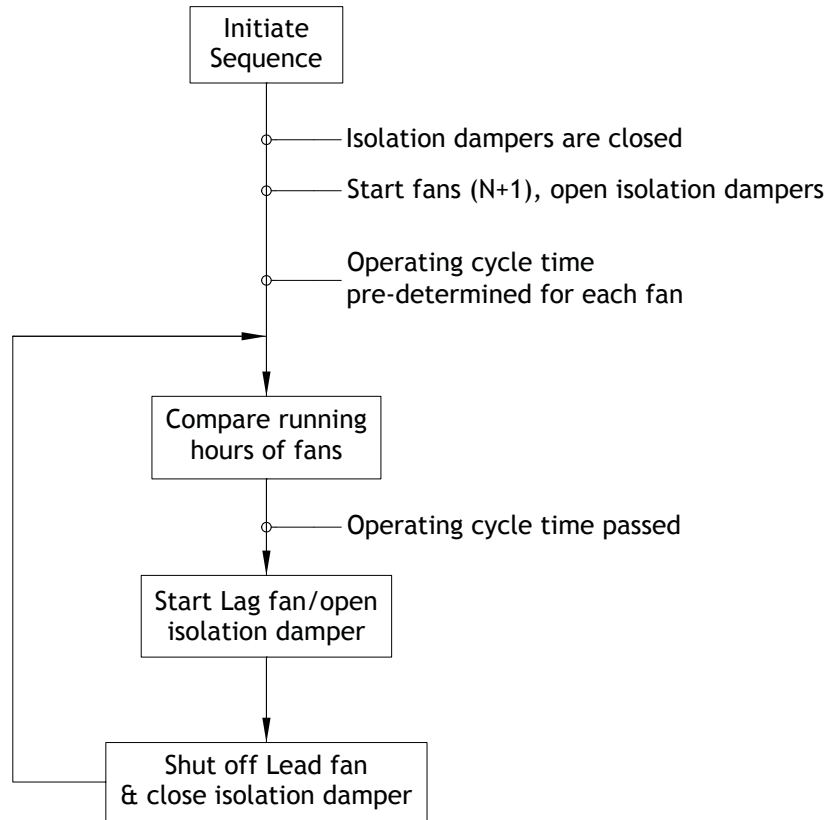

- Cycle time is pre-determined for each fan.
- When the cycle time has passed -
 - ◊ The Lag fan motor will start.
 - ◊ After a delay, (pre-determined at the factory), the Lag fan isolation damper will open.
- As soon as the Lag fans isolation damper starts to open, the Lead fan motor and its isolation damper will shut down simultaneously.
- During the Lead/Lag cycling there could be a pressure fluctuation to within +/-10% for a short period of time, which will last no longer than 30 seconds.

NOTE: Fan Cycling Control on the PLC touch pad allows the user to view actual total hours of operation of each fan, current time of the cycle and adjust the time in hours for LeadLag operation.



FANS RUNNING ON VARIABLE FREQUENCY DRIVES (VFD), NO BYPASS DAMPERS

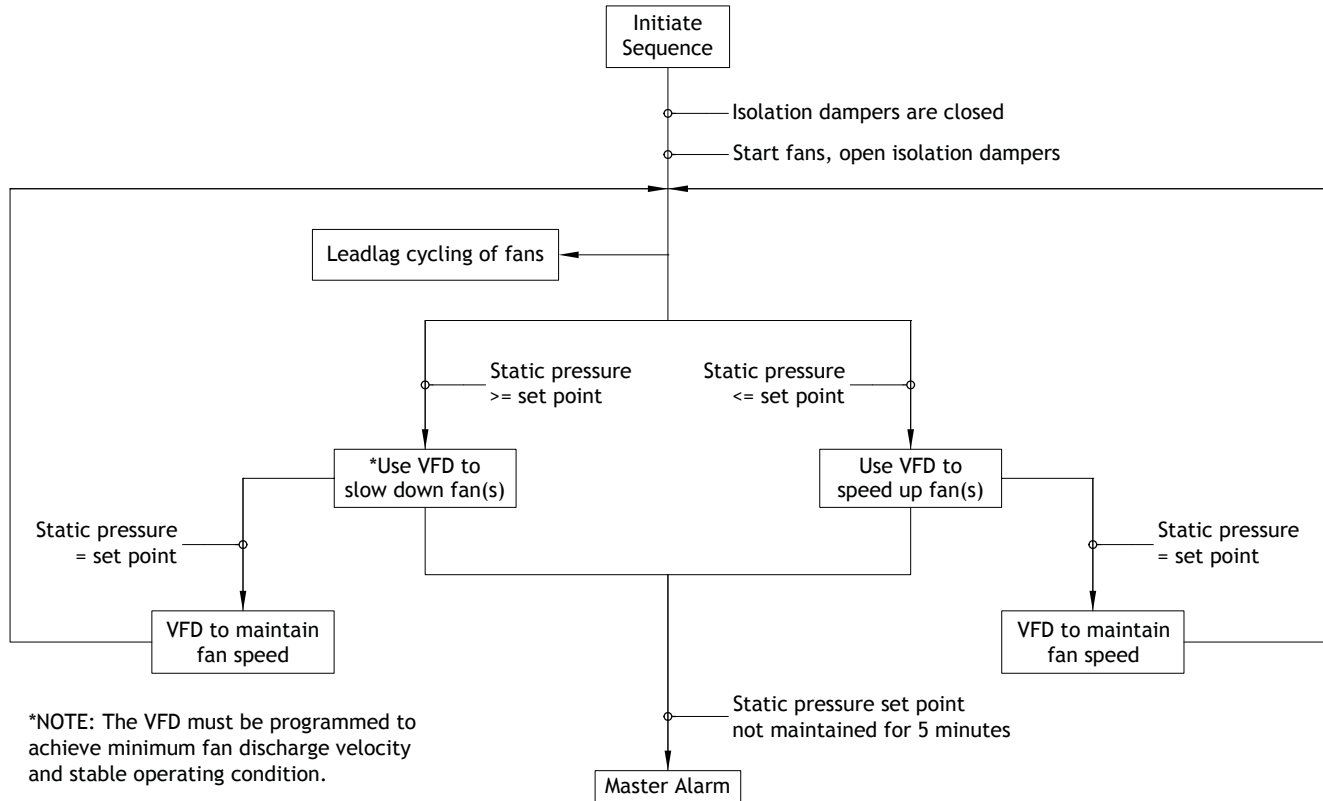

Static Pressure Set Point Too High

- If the static pressure set point in the system is too high (detected by the PLC), the VFD will slow down the fan(s) until the static pressure set point is achieved. The VFD will maintain the fan speed.

Static Pressure Set Point Too Low

- If the static pressure set point in the system is too low (detected by the PLC), the VFD will speed up the fan(s) until the static pressure set point is achieved. The VFD will maintain the fan speed.
- If the static pressure set point is not maintained (too high or too low) for 5 minutes, the system Master Alarm will be activated.

*Care should be taken when programming the VFD to allow for minimum desired fan flow, outlet velocity and plume height of the fans. ANSI Z9.5 recommends a minimum stack discharge velocity of 3,000 fpm for laboratory exhaust applications.

Client must provide the Profibus DP cables and connectors from the Leadlag PLC control panel to the VFD's.

FANS RUNNING WITH BYPASS DAMPER, NO VFD

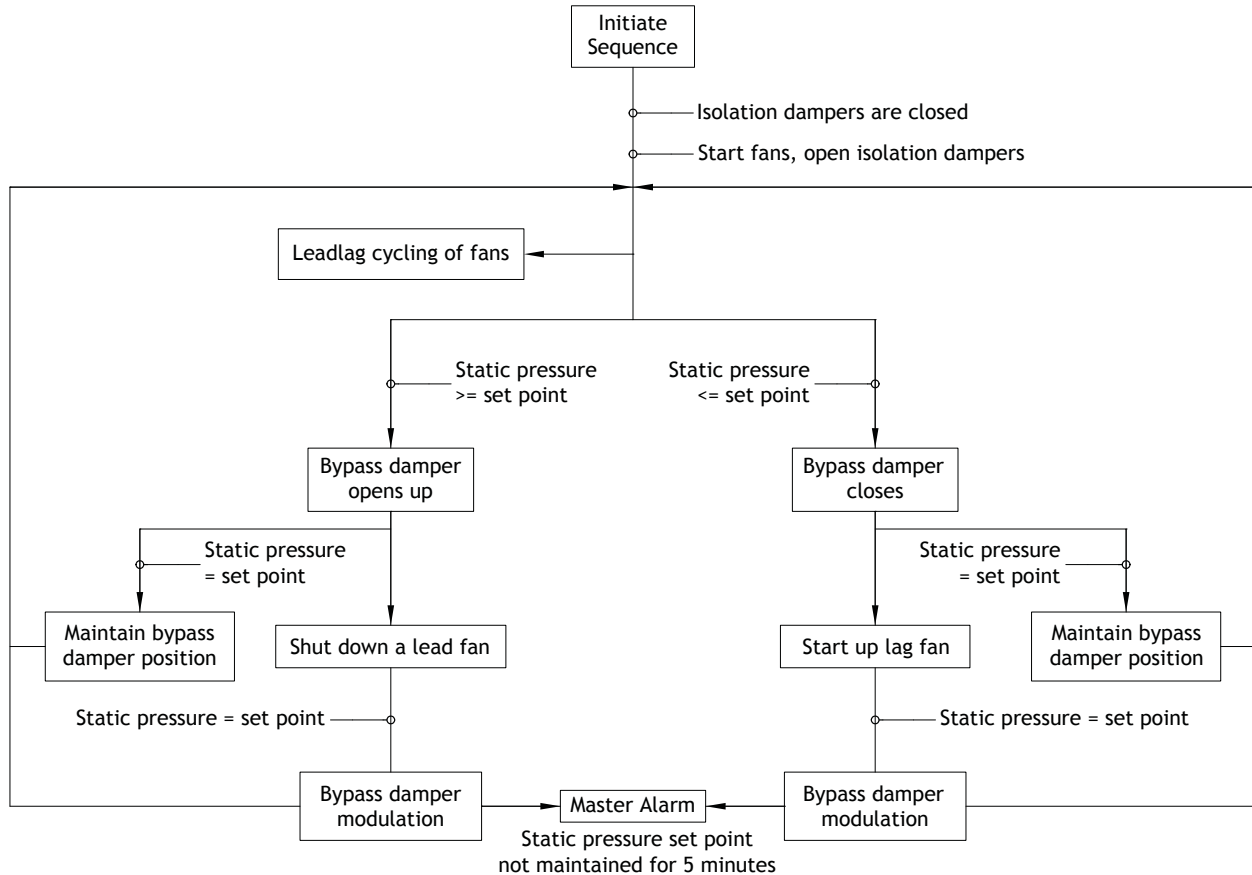

Static Pressure Set Point Too High

- If the pressure in the plenum is too high (detected by the PLC), the bypass damper will open to its maximum open position.
- If the pressure is still too high in the plenum longer than 3 minutes, (pre-set time at the factory and field adjustable), the system will disengage one of the Lead fans, as follows -
 - ◊ The Lead fan motor and isolation damper will shut down simultaneously.
- Once the Lead fan motor is de-energized, the bypass damper will go back to its continuous modulating zone.

Static Pressure Set Point Too Low

- If the pressure in the plenum is too low (detected by the PLC), the bypass damper will fully close.
- If the pressure is still too low in the plenum, longer than 3 minutes, (pre-set time at factory and field adjustable), the system will engage one of the Lag fans, as follows -
 - ◊ The Lag fan motor will start and after a delay, (pre-determined at the factory), the Lag fan isolation damper will open.
- Once the Lead fan has come to full operation, the bypass damper will go back to its continuous modulating zone.
- If the static pressure set point is not maintained (too high or too low) for 5 minutes, the system Master Alarm will be activated.

FANS RUNNING ON VARIABLE FREQUENCY DRIVES (VFD), WITH BYPASS DAMPERS

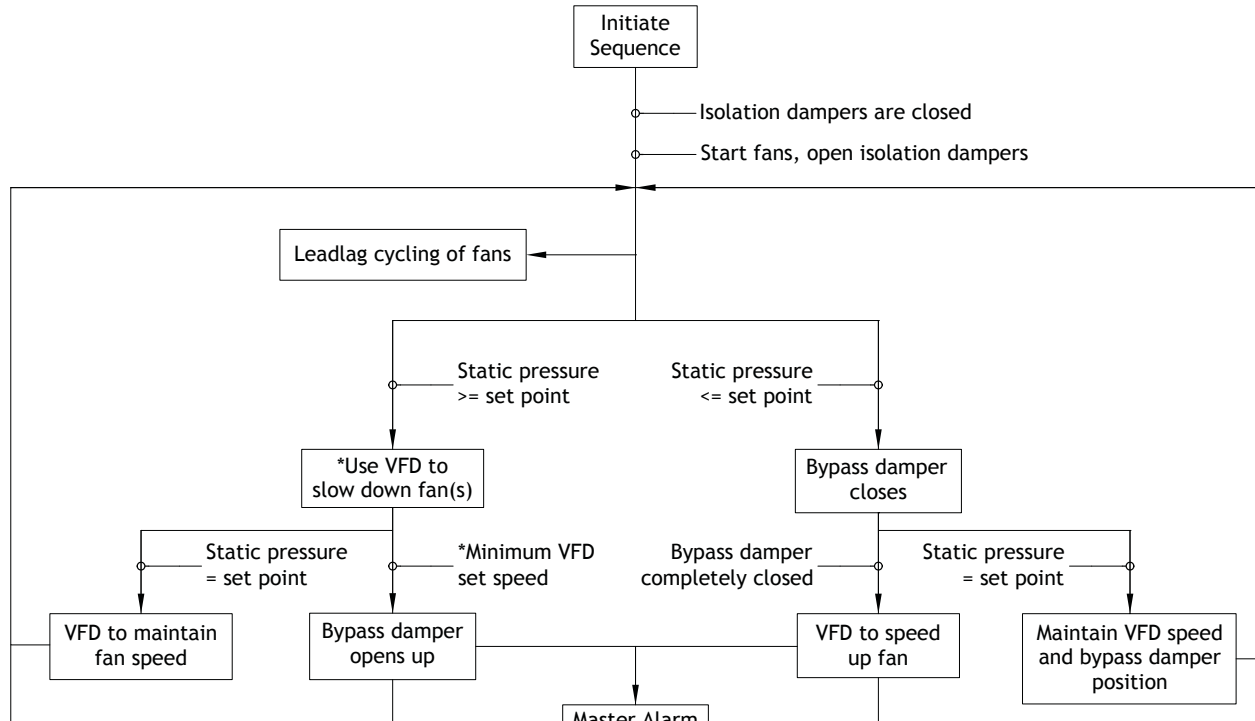

*NOTE: The VFD must be programmed to achieve minimum fan discharge velocity and stable operating condition.

Static pressure set point not maintained for 5 minutes

Static Pressure Set Point Too High

- If the static pressure set point in the system is too high (detected by the PLC), the VFD will slow down the fan(s) until the static pressure set point is achieved. The VFD will maintain the fan speed.
- If the pressure is still too high in the plenum and the minimum programmed VFD speed has been reached, the bypass damper will open to achieve pressure set point.

Static Pressure Set Point Too Low

- If the pressure in the plenum is too low (detected by the PLC), the bypass damper will close until static pressure set point is reached.
- If the static pressure set point in the system is still too low, the VFD will speed up the fan(s) until the static pressure set point is reached. The VFD will maintain the fan speed.
- If the static pressure set point is not maintained (too high or too low) for 5 minutes, the system Master Alarm will be activated.

LABORATORY EXHAUST FAN CONTROL

1. The laboratory exhaust fan manufacturer shall supply an electronic control system to monitor and control the operation of the laboratory exhaust fans.
2. The Leadlag™ laboratory exhaust fan control system shall control the sequential operation of the exhaust fans on a common plenum, and the periodic cycling of the (n + 1) standby fan while maintaining the system design static pressure to within + or - 10% for a 30 second period of time during sequencing.
3. Leadlag™ to include energy saving mode, to reduce the quantity of fans in operation and minimize outside bypass air requirement, therefore reducing energy consumption.
4. The standby fan shall be activated on a two week cycle, (standard standby cycle to be field modified, if required).
5. If Leadlag™ system is provided with variable-frequency drive (VFD), VFD communication to be via. Profibus. Leadlag™ to provide all VFD control information.
6. Where specified, the Leadlag™ is to integrate into the existing Building Automation Control Network through BACnet or Lonworks communication protocol
7. Where specified, the Leadlag™ is to include a fan failure (alarm), enabling to switch from Lead Fan to Lag Fan in the event of temperature limit, vibration limit, belt failure, isolation damper failure and fan flow failure.
8. The system shall have a Network Interface Card to facilitate the controls manufacturer in monitoring the functioning of the system remotely. Local I.P. addresses are required.
9. The system shall be configured to respond to operating parameters, and provide output signals for monitoring and reporting status of the system components, as required by the specification. Parameters such as static pressure to be field modifiable.
10. The system shall include a main PLC Control Panel Unit (PCPU), in a NEMA 1 enclosure, to be located inside the building that will contain a microprocessor to control the proper operation of the laboratory exhaust fan system.
11. The PCPU shall include an interactive touch screen that will display operational, fans and alarms status.
12. The PCPU must have controls for Manual or Automatic operation.
13. A secondary NEMA 3R enclosure, the Auxiliary Actuator Pressure Control Unit (AAPCU), to be attached to the plenum and to contain the tubes for reading and maintaining Static Pressure and to contain terminals for damper actuator control wiring.
14. The two NEMA enclosures to be field wire connected for communication of signals for static pressure control for fan isolation and plenum bypass air dampers.

LABORATORY EXHAUST FAN CONTROL, *Continued...*

15. The laboratory exhaust fan system shall be manufactured and supplied by M.K. Plastics and to include fan, plenum, damper and damper actuators.
16. M.K. Plastics supplied plenums shipped to the job site shall have the AAPCU attached to the plenum. The wiring and controls for damper actuators and the tubing for Static Pressure shall be installed by M.K. Plastics and to be tested and certified prior to shipment. Connection wiring between the PCPU and the AAPCU to be done in the field by the contractor.
17. The subcontractor doing the Leadlag™ wiring and installation of the control system on the job site, shall be under the supervision of a representative from M.K. Plastics.
18. The controls for the laboratory exhaust system shall be Leadlag™, to be supplied by M.K. Plastics Corporation.

Leadlag™ - PATENT PENDING



Representative:
MK Job No:
Project:
Engineer:
Date:
System No:
Scope Revision & Date:

AXIJET[®] LEADLAG[™] EXHAUST FAN CONTROL SYSTEM SCOPE - INFORMATION - QUESTIONNAIRE

The purpose of this document is to make the Leadlag controller custom suited and pre-programmed for the needs of the end user. To do this, we have supplied this scope that will give you an insight into the operation, capabilities and options available. We also need your help answering a few questions that will help us design, build and supply the correct Leadlag Control System.

1. How many fans will be integrated into the Leadlag system?

- 2 fans
 3 fans
 4 fans
 5 fans
 Other

Quantity of fans: _____

Will there be a redundant fan setup?

- YES NO

2. Do you require standard Leadlag operation? (Cycling between Lead & Lag fans, no pressure control)

- YES NO

3. The default time between Leadlag fan cycling (setup at the factory) will be 14 days per fan.

*Please specify an alternate cycle time if required: _____

*This time can also be changed on the job site (field programmable on the PLC).

4. *Are isolation damper control actuators supplied by M.K. Plastics?

- YES NO

*Please note that isolation damper control actuators are to have a feedback signal, or 'end-switches' built in.

If 'No', please provide make & model of control actuator: _____

5. Is the bypass plenum supplied by M.K. Plastics?

- YES NO

6. How many bypass dampers are in the system? _____

7. Are bypass damper control actuators supplied by M.K. Plastics?

- YES NO

If 'No', please provide make & model of control actuator: _____

8. Do you require Leadlag control system with static pressure control?

YES NO

(Static pressure setpoint is field programmable on the PLC)

If 'YES'...

Static pressure sensor in the plenum?

Remote static pressure location?

Remote static pressure location with multiple inputs (lowest point or average reading)?

Static pressure in plenum + ductwork location + remote location (static pressure reading will be combined total)?

Specify other, or additional information:

9. In the event of a power failure, is the system required to automatically restart after recovery of power?

No

Yes, in AUTO mode only

Yes, in MANUAL mode only

Yes, in both AUTO & MANUAL modes

10. Please indicate if Variable Frequency Drives (VFD) will be used:

YES NO

10a. If VFD's are being used, reduce VFD fan speed before opening bypass damper?

YES NO

10b. See table below for Design, Minimum, Maximum VFD operating conditions -

	CFM	S.P. (inch)	RPM	Outlet Velocity (fpm)
Design				
Minimum				
Maximum				

If VFD's are being used, Client must provide the Profibus DP cables and connectors from the Leadlag PLC control panel to the VFD's. Care should be taken when programming the drives to allow for minimum desired fan flow, outlet velocity and plume height of the fans.

Please indicate make and model of VFD's being used:

VFD must include integrated manual bypass mode.

The VFD fan speed(s) can be viewed on the PLC or BAS Communication, (field programmable on the PLC).

11. *Is bypass Energy Saving Model required?

YES NO (field programmable on the PLC)

*With Energy Saving Mode enabled, the PLC will monitor the bypass damper(s) position and if it is determined that the system is receiving too much bypass air, the PLC will shut down a fan. System static pressure will then be maintained by reducing and modulating the bypass air. Note, the system will shut down all but one fan in this mode. If the system static pressure is reduced, the PLC will engage one of the Lag fans.

12. *Is emergency smoke & fire mode required?

YES NO

12a. If yes, fan:

ON OFF

*Fans on or off (depending on State or Local Authority Codes)

13. *Do you require a BAS communication IP option compatible for the Building Automation Control Networks?

YES NO

If 'YES', please indicate either:

BACNet
or LonWorks

14. *Is a Network IP required for internet connection to facilitate M.K. Plastics to monitor the functioning of the system remotely?

YES NO *(Viewable only)

If 'YES', please provide two IP Addresses:

1). _____
2). _____

15. Alarm Mode; the Leadlag Control System can monitor and inform the end user of any possible equipment failures. As standard, these include the following -

- Fan flow rate alarm (failure of air to be exhausted out of the fan discharge).
- Isolation damper alarm (no exhaust reaching the fan inlet)

There also various additional alarm mode options available. Please indicate if you wish the following:

Vibration YES NO

Bearing temperature YES NO

16. The Leadlag Control System not only manages operation, but also informs the end user of what is going on.

The following table indicates what is programmable and viewed

	STANDARD DESIGN		BAS COMMUNICATION OPTION	
	Touch Screen View Only	View & Touch Screen Program	View Only	View & Program
Pressure transducer set-up	<input type="checkbox"/>	<input checked="" type="checkbox"/>	<input type="checkbox"/>	<input type="checkbox"/>
Leadlag cycle	<input type="checkbox"/>	<input checked="" type="checkbox"/>	<input type="checkbox"/>	<input type="checkbox"/>
Date & Time	<input type="checkbox"/>	<input checked="" type="checkbox"/>	<input checked="" type="checkbox"/>	<input type="checkbox"/>
Default energy mode	<input type="checkbox"/>	<input checked="" type="checkbox"/>	<input type="checkbox"/>	<input checked="" type="checkbox"/>
Fan run time	<input checked="" type="checkbox"/>	<input type="checkbox"/>	<input checked="" type="checkbox"/>	<input type="checkbox"/>
Static pressure set point	<input type="checkbox"/>	<input checked="" type="checkbox"/>	<input type="checkbox"/>	<input checked="" type="checkbox"/>
Actual static pressure	<input checked="" type="checkbox"/>	<input type="checkbox"/>	<input checked="" type="checkbox"/>	<input type="checkbox"/>
Fan status (on/off)	<input checked="" type="checkbox"/>	<input type="checkbox"/>	<input checked="" type="checkbox"/>	<input type="checkbox"/>
VFD/Fan speed	<input type="checkbox"/>	<input checked="" type="checkbox"/>	<input type="checkbox"/>	<input checked="" type="checkbox"/>
Bypass damper position	<input checked="" type="checkbox"/>	<input type="checkbox"/>	<input checked="" type="checkbox"/>	<input type="checkbox"/>
Fan flow alarm	<input checked="" type="checkbox"/>	<input type="checkbox"/>	<input checked="" type="checkbox"/>	<input type="checkbox"/>
Fan isolation damper arm	<input checked="" type="checkbox"/>	<input type="checkbox"/>	<input checked="" type="checkbox"/>	<input type="checkbox"/>



Any additional instructions or comments?

Signed :

Name :

Title/Position :

Company/Organization :

Date :

CONDITIONS OF SALE

1. Prices quoted are current; prices prevailing at time of shipment will apply. Material in stock is offered subject to prior sale. All Sales Contracts arising out of this quotation shall be subject to our regular conditions shown on this side.
2. All deliveries quoted are based on availability of material and labor at the time of quotation and subject to changes. Deliveries are contingent upon strikes, accidents, fires and other causes and we shall not be liable for any loss or damage caused by delays beyond the control of the company.
3. Goods invoiced up to and including the last day of the calendar month, shall be paid for not later than the last business day of the following month. The Company reserves the right to charge interest at commercial rates on any overdue account.
4. Any order accepted by us cannot be countermanded, revised or cancelled without our written consent and upon such terms as will indemnify us against any loss. The word "loss" as used herein shall include, but not be limited to, cost of materials, special machinery, tools, jigs and fixtures built or purchased for the contract and all parts in process, fabricated in whole or in part by previous customer authorization.
5. No contract arising from the acceptance of this quotation shall be valid and binding until approved by the company, such contract shall be governed by and interpreted in accordance with the laws of the Province of Québec.
6. All memoranda, drawings and information furnished by the company shall remain its property and shall be considered business or trade secrets received in trust and confidence for the sole purpose of assisting the buyer.
7. Orders to customer's drawings or descriptions are filled with the understanding that the customer assumes the obligation to protect M.K. Plastics Corporation from any action for infringements of patents.
8. No modification of the above conditions of Sale shall be effected by our receipt or acknowledgement of a purchase order containing additional or different conditions.

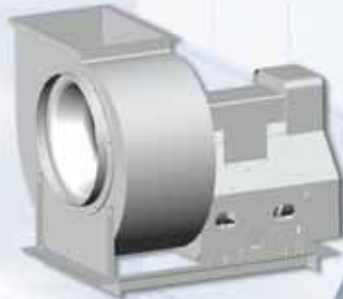
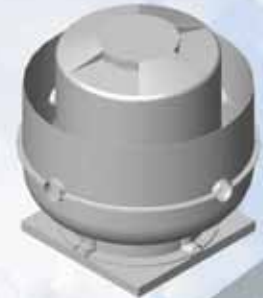

LIMITATION OF WARRANTY AND LIABILITY

M.K. Plastics will not be responsible for the damage to equipment or materials through improper installation, storage, improper servicing, or through attempts to operate it in excess of its rated capacity or recommended use, intentional or otherwise. We will not be responsible for consequential damage.

Based on the fact that M.K. Plastics Corp. has no direct control over the actual handling and use of its products in the field, M.K. Plastics Corp. does not assume any liability for any loss of customer or any personnel or any physical damages claimed by anyone due to a failure or cause attributed to the use of its products. In no event shall M.K. Plastics Corp. be responsible for consequential damages of any such defective material or workmanship, including but not limited to the buyer's loss of material or profit, increased expense of operation, downtime or reconstruction of the work and in no event shall M.K. Plastics Corp. obligation under this warranty exceed the original contract price of the defective item.

M.K. Plastics Corp. warrants its equipment, products and parts, to be free from defects in workmanship and material under normal use and service for one (1) year after delivery to the first user. Our obligation under this warranty being limited to repairing or replacing, at our option, without cost at our factory any part, or parts which shall, within such warranty period, be returned to us with transportation charges prepaid, and which our examination shall disclose to our satisfaction to have been defective.

M.K. Plastics Corp. will not be responsible for the cost of removal of a defective product or parts or the installation of a replaced product or parts, or for costs due for its removal, crating or shipping.

On account of variables including but not limited to, vibration, system noise characteristics, motor overloading or change in voltage conditions, the specifics of customer application of equipment or other system conditions, M.K. Plastics Corp. does not expressly warrant its equipment for any specific purpose.

The customer and its agents are responsible for the selection and application of M.K. Plastics Corp. products, including their fitness for the purpose and performance intended. Consequently, the customer on behalf of its agents assumes all liability related to the use/misuse, application and selection of the M.K. Plastics equipment.

M.K. Plastics
CORPORATION

SERVING THE NEEDS OF MODERN INDUSTRY

4955 De Courtrai Ave., Montreal, Quebec H3W 1A6
Trimex Building, Route 11, Mooers, NY 12958
Spiez, Switzerland

tel: (514) 871-9999 / (888) 278-9988 fax: (514) 871-1753
www.mkplastics.com

77-04-FEBRUARY-2011